



Anker Innovations Limited. All rights reserved. eufy Security and eufy Security Logo are trademarks of Anker Innovations Limited, registered in the United States and other countries. All other trademarks are the property of their respective owners.

51005002837 V01



QUICK START GUIDE

SoloCam S40

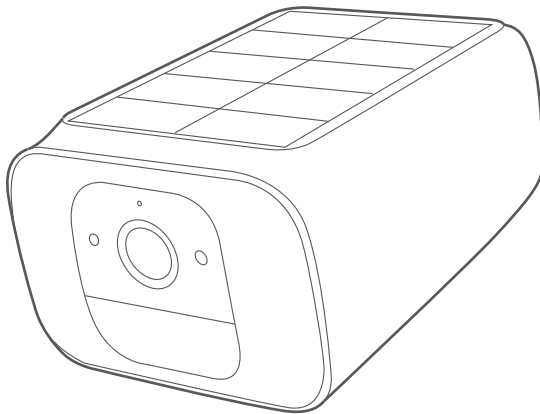

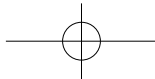
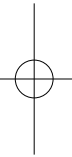
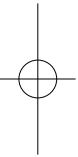
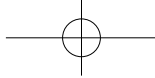
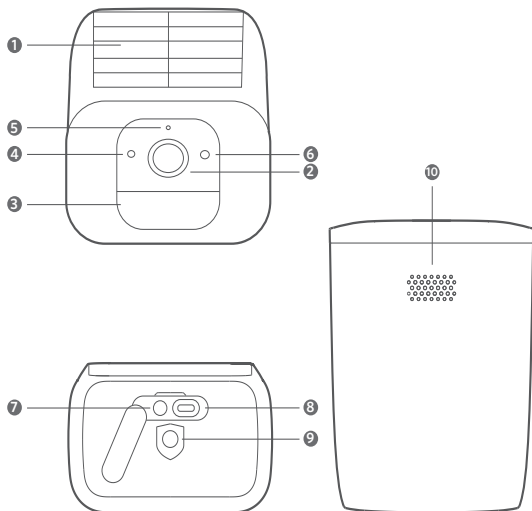

TABLE OF CONTENTS

PRODUCT OVERVIEW	02	05	MOUNTING SOLOCAM
CHARGING SOLOCAM	03	08	NOTICE
SETTING UP SOLOCAM	04		

PRODUCT OVERVIEW



- 1. Solar Panel
- 2. Camera Lens
- 3. Motion Sensor
- 4. Photosensitive Sensor
- 5. Microphone

- 6. LED Indicator
- 7. SYNC Button
- 8. Type-C Charging Port
- 9. Mounting Hole
- 10. Speaker

2 / CHARGING SOLOCAM

Battery-powered

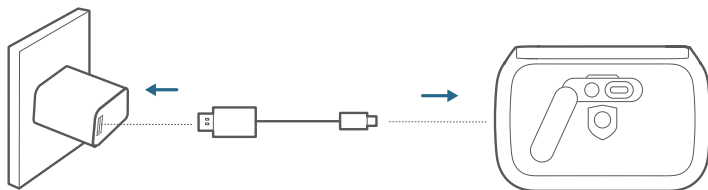

Charging	Solid blue
Fully charged	Off

3 / SETTING UP SOLOCAM

Download the App and Set up the System

1. Download and install the eufy Security app, and sign up for an account.



2. Follow on-screen instructions to add your SoloCam .

4 / MOUNTING SOLOCAM

Select a Location

SoloCam S40 can be mounted on a wall. Select a location where you can get the desired view. We recommend hanging it 7-10 ft (2-3 m) above the ground.

- 💡 To maximize the solar panel efficiency, select a location where SoloCam S40 can receive more sunlight.

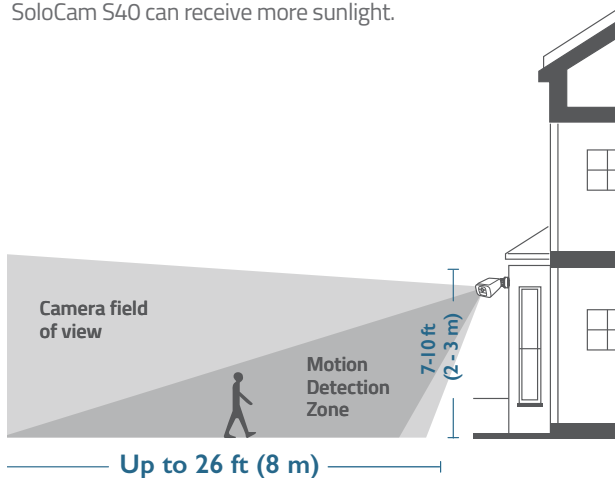

Mount SoloCam S40

SoloCam S40 can be mounted both outdoors and indoors.

1. Turn the knob of the mounting bracket counterclockwise to loosen and disassemble it.

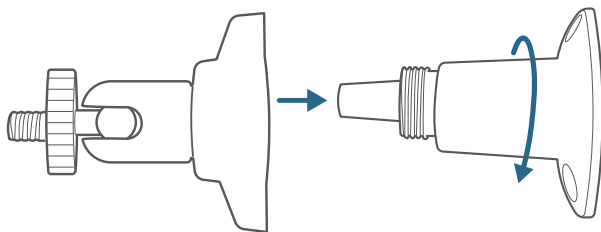

2. Place the mounting bracket against the wall. Drill holes with a 15/64 inch (6 mm) drill bit, then insert the anchors into the holes; anchors are necessary for walls that are made out of hard materials such as concrete, brick, or stucco.

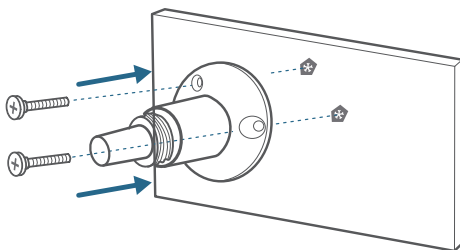

3. Firmly screw the knob of the mounting bracket into the mounting hole of SoloCam.

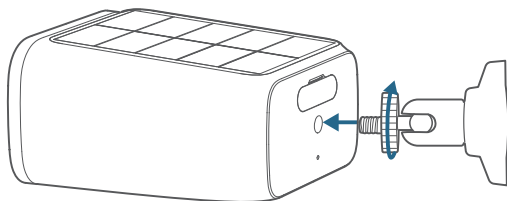

4. Hold and screw SoloCam to the mounting bracket. Rotate SoloCam to adjust the view and check it using the live stream which you can access in the eufy Security app.

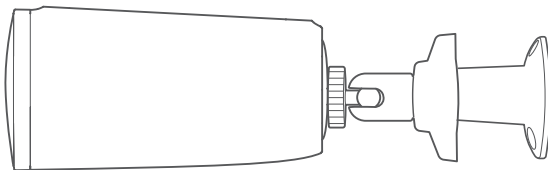

SoloCam S40 can be also installed on the ceiling. Follow the steps 1-4 mentioned above to install it.

Tips:

For troubleshooting, check Help on the eufy Security app. Refer to the app page for LED indicator status.



5 / NOTICE

FCC Statement

This device complies with Part 15 of the FCC Rules. Operation is subject to the following two conditions: (1) this device may not cause harmful interference, and (2) this device must accept any interference received, including interference that may cause undesired operation.

Warning: Changes or modifications not expressly approved by the party responsible for compliance could void the user's authority to operate the equipment.

Note: This equipment has been tested and found to comply with the limits for a Class B digital device, pursuant to Part 15 of the FCC Rules. These limits are designed to provide reasonable protection against harmful interference in a residential installation.

FCC Radio Frequency Exposure Statement

The device has been evaluated to meet general RF exposure requirements. The device can be used in fixed/mobile exposure condition. The min separation distance is 20 cm.

Note: Shielded cables

All connections to other computing devices must be made using shielded cables to maintain compliance with FCC regulations.

The following importer is the responsible party.

Company Name: POWER MOBILE LIFE, LLC

Address: 10900 NE 8TH ST, STE 501, BELLEVUE, WA 98004

Telephone: 1-800-988-7973

IC Statement

This device complies with Industry Canada licence-exempt RSS standard(s). Operation is subject to the following two conditions:

- (1) this device may not cause interference, and
- (2) this device must accept any interference, including interference that may cause undesired operation of the device.

Le présent appareil est conforme aux CNR d'Industrie Canada applicables aux appareils radio exempts de licence. L'exploitation est autorisée aux deux conditions suivantes:

- (1) l'appareil n' doit pas produire de brouillage, et

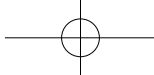

(2) l'utilisateur de l'appareil doit accepter tout brouillage radioélectrique subi, même si le brouillage est susceptible d'en compromettre le fonctionnement.

This Class B digital apparatus complies with Canadian ICES-003.

Cet appareil numérique de la classe B est conforme à la norme NMB-003 du Canada.

IC RF Statement

When using the product, maintain a distance of 20cm from the body to ensure compliance with RF exposure requirements.

Lors de l'utilisation du produit, maintenez une distance de 20 cm du corps afin de vous conformer aux exigences en matière d'exposition RF

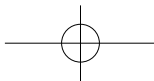
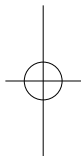
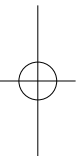

Customer Service

Warranty

12-month limited warranty

Call Us

United States

+1 (800) 988 7973

Mon-Fri 9AM-5PM (PT)

United Kingdom

+44 (0) 1604 936 200

Mon-Fri 6AM-11AM (GMT)

Germany

+49 (0) 69 9579 7960

Mon-Fri 6:00-11:00

Email Us

Customer Support: support@eufylife.com

Anker Innovations Limited

Room 1318-19, Hollywood Plaza, 610 Nathan Road, Mongkok,
Kowloon, Hong Kong

 @EufyOfficial

 @EufyOfficial

 @EufyOfficial

10 **EN**

